

**PORTIA
67" ACRYLIC
OVAL TUB**

Cat. No.
ATOV7H67IG



L: 66-3/4", 42-3/4" bottom
W: 38-3/8", 25-1/8" bottom
H: 23-3/8"

Tap deck: 4-3/4" x 16"
Water depth: 17-7/8" to top of tub
Water depth: 14-1/4" to OF
Overflow slot length: 3" x 1/2"
Center drain to back of rim: 19-3/8"
Bottom of drain to floor: 4"
Bathing well to floor: 5"
Sitting area: 15-1/2"
Base Height: 3"

The following is recommended for ATOV7H67IG with 7" center rim holes

- Faucets: part #4601,4603,4062,or 4064
- Straight bath supplies: #5577
- Requires flexible supplies



For easier installation we recommend use of 5598-ITD Easy Install Rough In Kit

Gallon Capacity with OF: 66
Shipping Weight: 154 lbs.
Empty Weight: 91 lbs.
Filled Weight with OF: 639 lbs.

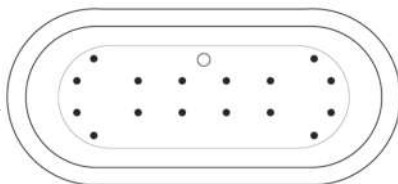

(Air jet configuration if system is added, more info on page 2.)

Features:

- ▶ Interior and exterior walls acrylic sheets
- ▶ Drain and overflow covers included (available in 6 finishes)
- ▶ Overflow slot with integrated drain
- ▶ Drain included
- ▶ Tub base included
- ▶ Rim measurement: 1-1/8"
- ▶ Includes built-in adjusters
- ▶ Tap deck with 7" deck holes
- ▶ Angle slope of tub: 59°
- ▶ Tub is thoroughly inspected before shipment
- ▶ Option to add foam insulation between tub walls available
- ▶ **New:** Air jet system now available, more info on page 2



Finishes:

- BN** Brushed Nickel
- CP** Polished Chrome
- ORB** Oil Rubbed Bronze
- PB** Polished Brass
- PN** Polished Nickel
- WT** White

Custom Colors Available (inside of tub is always white enamel):
Painted bathtubs are considered "special order" and are not returnable

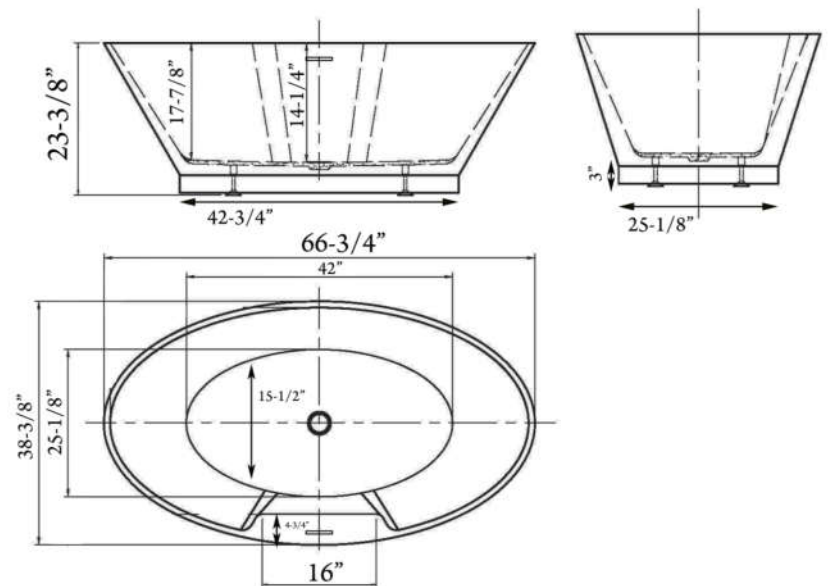

Dimensions of fixture are nominal and specifications subject to change without notice.

BATHTUB AIR JET KIT

Cat. No.
AIR KIT 1, AIR KIT 2

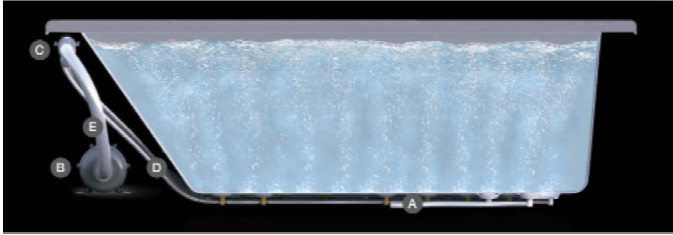

- A** AIR JET - Bottom air jets for maximum bubble action.
- B** BLOWER - The heart of the massage system.
- C** MANIFOLD - Double back flow security prevention device.
- D** FLEXIBLE PVC HOSEING - IAPMO certified.
- E** MAIN AIR INTAKE HOSE - High temperature and pressure resistant.

Features:

- ▶ 750 Watt blower motor operates system
- ▶ 300 Watt air heater warms air
- ▶ System powered by 120V
- ▶ 16 brass air jets placed in bottom of tub
- ▶ Each air jet has 24 holes
- ▶ Air jet caps available in white (AIR KIT 1) or black (AIR KIT 2)
- ▶ Includes 1 1/4" x 3' main air hose plus 1 1/4" x 9' extension hose
- ▶ Automatic system purge after each use
- ▶ Automatic safety timer turns off system after 20 minutes
- ▶ Includes water tight remote control
- ▶ Compatible with most acrylic, copper and resin tubs with no feet
- ▶ Not available with cast iron tubs or tubs with feet

Air Kit is installed in tub before shipment

INSIDE TUB VIEW - WILL VARY BY TUB DESIGN



Air Jet



Remote

Oval bathtub
Sample jet configuration

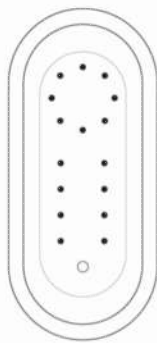

with end drain

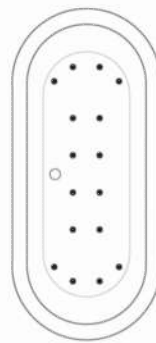

with center drain

Rectangular bathtub
Sample jet configuration

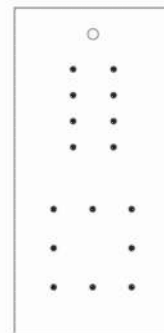

with end drain

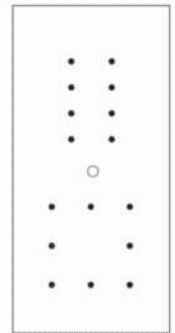

with center drain

Round bathtub
Sample jet configuration

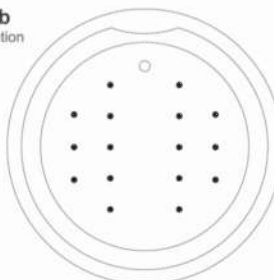

These diagrams are general representations.
Jet placement may vary dependent on tub shape

Features:

(16) Maxi Air Jets



Elbows for air jets



Tees for air jets